

# **Jordan Series Drogue**

## Table of Content

WHAT IS THE JORDAN SERIES DROGUE? .....	3
WHAT IS IT?.....	4
PERFORMANCE at SEA.....	5
Practical Seamanship Magazine .....	5
Hurricane .....	6
Rough Crossing, Ocean Navigator, No. 88 .....	6
Other Uses .....	7
New Skippers at Sea .....	7
32 ft. trimaran competing in a feeder race to Europe 1 STAR .....	7
Rough Trip to Iceland.....	7
35ft. Cheoy Lee Lion.....	8
Rhode 41, 70 degrees south in the Atlantic.....	8
A Tense Moment in Drogue History.....	9
Trawler Yachts 3-06 .....	9
A Good Ride .....	9
An Epochal Change in Storm Tactics .....	10
TECHNOLOGY .....	12
Research and Development Program -- Don Jordan.....	12
Quality Control .....	13
DESIGN LOADS and ATTACHMENTS.....	14
Drogue Design Load.....	14
Bridle Legs .....	14
Attachments on the Hull .....	14
LAUNCHING and RETRIEVAL .....	15
Launching the Drogue.....	15
Retrieving the Drogue .....	15
Chafe .....	16
ABOUT the DESIGNER .....	17
ABOUT the BUILDER .....	18
STORM WAVES.....	20
WAVE SCIENCE .....	22
Non-Breaking Waves.....	22
Breaking Waves .....	22
Worst Case Breaking Wave Strike .....	23
An Experiment.....	25
"THE LOSS OF THE WINSTON CHURCHHILL" .....	27
Winston Churchill with Drogue .....	27
MOORING AND ANCHORING .....	30
The Stability of Anchored or Moored Sailing Yachts.....	31
Water Forces: .....	32
Air Forces:.....	33
An Unstable System: .....	33
A Stable System: .....	33
An Engineered Design for Moorings: .....	34
Additional Information .....	36

## WHAT IS THE JORDAN SERIES DROGUE?

The Jordan Series Drogue is a safety device designed to prevent the capsize and damage of both monohull and multihull sailing yachts and other vessels operating in the open ocean, in the event of a "worst case" breaking wave strike, as well as improving the motion of the boat in storm waves and to reduce drift.

The Jordan Series Drogue has been at sea for over 15 years. At least 1000 are in use all over the world. The drogue has been deployed through many storms including several hurricanes. No boat has ever been damaged and no crew injured. A typical comment from the skipper is "I did not feel threatened."

The series drogue has been developed using modern engineering technology, including model tests in wave channels, computational dynamic analysis, and full scale testing by the U.S. Coast Guard at their motor life boat testing facility where boats are subjected to breaking waves formed on the Columbia River bar.



The drogue consists of a number of small cones woven into a tapered line with a small weight at the end. The maximum design load and the number of cones is determined by the displacement of the boat.

Some skippers call it "THE SAILORS AIRBAG"

The drogue is available in kit or complete form from [Ace Sailmakers](#).

The drogue is designed to protect the boat in a "Worst Case" breaking wave strike. Engineering data for the design was obtained from the 1979 Fastnet Race disaster (See Fastnet Force Ten by John Rousmaniere) in which 15 lives were lost and 24 boats sunk or abandoned, and further supported by data from the 1998 Sydney - Hobart race in which 5 yachts were sunk, 6 sailors died and 55 crew were winched to safety by helicopters. (See Fatal Storm by Rob Mundle) No boats carried the drogue in these storms. There is now convincing evidence that the drogue would have brought all the boats through safely.

## WHAT IS IT?

The Jordan Series Drogue is a safety device deployed from the stern of the vessel.

It consists of a bridle, a leader and a tapered line with from 100 to 200, 5 inch diameter cones attached. A 15 to 25 lb. chain is then attached to the end. The number of cones and rope diameter is adjusted for the displacement of the vessel.

The figure below shows a computer simulation of a 55 ft yacht in the trough of a 45 ft breaking wave in the 1998 Sydney Hobart Race. A series drogue is deployed.

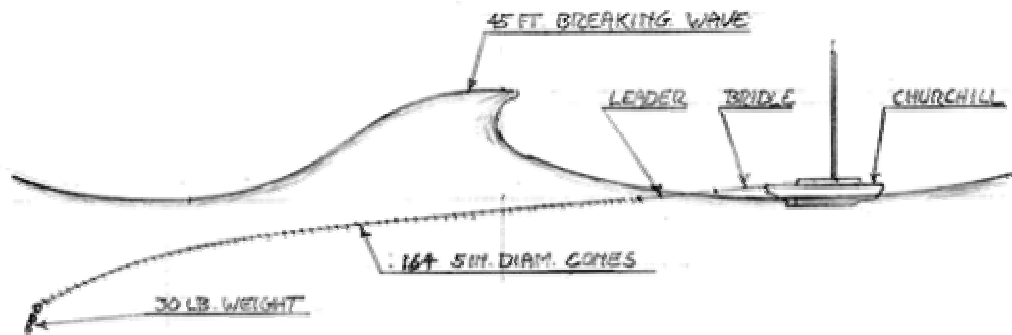

[Ace Sailmakers](http://AceSailmakers.com) makes the series drogue or has it available in kit form or [JordanSeriesDrogue.com](http://JordanSeriesDrogue.com)

## **PERFORMANCE at SEA**

The series drogue has been at sea for over 20 years. No boat has ever been damaged and every skipper has expressed satisfaction with its performance.

### ***Team Philips***

Perhaps the most dramatic example is the story of the giant catamaran Team Philips, a boat that was designed for "The Race", a non-stop race around the world with essentially no design restrictions. The boat was highly unconventional with two 135 ft. hulls and two 135 ft. unstayed rotating wing masts, one on each hull. A crew pod, the bottom of which was 11 ft above still water, was attached between the hulls.

The boat, which was built in England, was launched much later than intended. Finally it was taken to London and ceremonially blessed by the Queen. Problems encountered during early trials caused further delays. To qualify for the race it was necessary to complete a transatlantic round trip crossing. The time was Dec. 01 and the time for further trials had run out. The skipper resigned rather than attempt the crossing. Another skipper took over and the crew of 6 set out in early Jan. About 800 miles out they encountered a typical winter storm. They had no choice but to run before it. The boat surfed down the face of the large waves at 15 to 20 knots and plunged into the trough with a violent impact. In the middle of the night the crew pod began to break loose from the attaching structure.

By the greatest good fortune, one of the shore crew had insisted that a series drogue be carried and that it be pre-rigged so that it could be launched from the pod simply by dropping the length of chain in the water. Within minutes of launching, the boat slowed down to 1.5 knots and rode comfortably. They reported that they could feel the drogue gently decelerate the boat as it rode the wave face.

In the morning they managed to contact a container ship. When it arrived they retrieved the drogue, which was in good condition, and managed to maneuver the boat alongside the container ship where all six were able to scramble up a net and board the ship.

The next day the epir signal stopped and an aerial search failed to find the boat. It was presumed to have sunk.

The crews comment: "It was a real life saver". .

### ***Practical Seamanship Magazine***

Contest 40, 250 mi. N. W. of Bermuda. "Gusts were furious now. The seas were 25 ft with faces at 45 degrees and breaking crests. Deployed drogue. Slowing effect was phenomenal. Deploying the drogue was like jumping off a 30 ft. wave with a 40 ft. yacht. The feeling of being elastically tied to the sea itself is hard to imagine. We slowed to 1.5 knots with the stern pointed aggressively into the sea. It was as though we had entered a calm harbor of refuge. With the reduction in the yachts motion our situation seemed to be not too bad. We were exhausted and took the opportunity to get some sleep".

Many skippers have commented on the bungee type feel to the boats motion with the drogue deployed. This important characteristic was developed from model testing in the U.S. Coast Guards flow channel, which has glass walls so the underwater motion of drogue models could be observed. In a major storm, a yacht moves forward as it passes over the crest and backward in the trough for a distance of 50 ft. or more. The length of the drogue and the weight at the end is designed so that the drogue normally assumes a hook shape with the weighted end hanging almost vertical. When the boat is passing over the crest the drogue tends to straighten out and more of the cones take up the load thus checking the boat. In the trough, the weight sinks, taking up the unwanted slack in the towline. Thus the drogue is always aligned to respond to a dangerous breaking wave strike. The cones are attached at both ends so they cannot turn inside out if moving backward.

Model tests clearly show that the behavior of a parachute or cone drag device is unacceptable. As the device is pulled forward, it forms a wake behind it. When the towline goes slack the water in the wake continues to move forward and turns the chute or cone inside out, often causing it to tumble or foul the shroud lines. In the Coast Guard full scale tests in breaking waves on the Columbia River bar, the series drogue performed flawlessly and was retrieved with no damage, while a cone type drogue was destroyed.

### ***Hurricane***

A Tartan 38 left Beaufort, N. C. just after Hurricane Gordon passed over Florida and into the Gulf of Mexico. Unfortunately, the storm reversed direction and recrossed Florida back into the Atlantic, catching the boat a couple of hundred miles out. The storm brought 75 knot winds and 30 ft waves. The crew deployed the drogue at 2.00 PM and rode throughout the night in relative comfort. The boat was undamaged.

During the same storm, the Coast Guard airlifted to safety the crew of the 42 ft. ketch Seaflower.

### ***Rough Crossing, Ocean Navigator, No. 88***

This is an interesting and instructive description. The skipper and his wife in a 35 ft. aluminum cutter were on a passage from Newfoundland to England in August, 97. They ran into a storm with two successive lows reaching Force 10 (48 to 55 knots). The eye passed directly over the boat. Waves were estimated up to 25 ft. with numerous breaking crests. The drogue held the boat to a yaw of less than 20 degrees and ride was reasonably comfortable. The boat incurred no damage and the drogue was retrieved in good condition.

Since the skipper was aware that the wind would return from a different direction, he left the drogue deployed when the boat was in the lull. He reported considerable rolling and yawing as the wind shifted 180 deg. The cockpit filled several times as random waves slopped aboard. The skipper said that he never felt endangered in the force 10 conditions. The series drogue is designed to sink straight down when the boat has no way on - as was the case here. There have been a number of instances where a single cone type drogue has drifted or been driven forward and has fouled the propeller or rudder.

### **Other Uses**

Magazine Latitude 38, from a 35 ft. Sloop captain....”but the surprising thing is that you don't have to experience storm force winds in order to get good use out of the drogue... Rita and I were alone in near gale conditions. After fighting the weather for two days we were both exhausted. Deploying the drogue was quicker and easier than heaving to. Further, it allowed us to continue on our downwind course at a speed of 1.5 knots, despite the 35 knot winds. During the night the conditions got much worse and I was quite happy to stay on the cabin sole and feel sorry for myself. I remembered when Rita was building the drogue I'd pronounced that we would "never use that thing".

### **New Skippers at Sea**

With the advent of fiberglass yachts and modern navigation gear more sailors are venturing offshore, even if only for one or two nights at sea. The drogue has proven useful in a number of instances:

"My wife, two sons, and I recently sailed our catamaran from Miami to Tortola, B.V.I. We took the offshore route through Providence Channel, and stayed north until 65 west. Two days out and 150 miles from land we were caught in a full gale, wind speeds to 40 knots and wave heights 16 to 20 ft. The boat began to surf down into the troughs under bare poles. I had pre-rigged the drogue so that all I had to do was to drop the chain over the stern. In less than one minute the world went from life threatening to easy motion and one knot drift.

I feel strongly that without the drogue we would have gone end over end. We stayed on the drogue for 24 hours"...

### **32 ft. trimaran competing in a feeder race to Europe 1 STAR**

"A Busy Month For The U.S. Coast Guard's Vessel Rescue Net Work"

- Port hull forward cross member had snapped- 700 miles southeast of Nantucket-gale force winds, 20 ft. seas- mast blown down - hulls smashing together.
- Set series drogue and activated EPIRB - readied life raft and donned survival suit.
- Skipper David Dietz: "When something so out of control as this happens there isn't much else you can do other than having a good meal and listening to some Jimmy Buffet" which is what he did.
- A cargo ship was directed to him by a Coast Guard aircraft and he was picked up about 5 hours later and taken to Norway.
- Note that he reported no further damage to the boat after the drogue was deployed.

### **Rough Trip to Iceland**

Yachting Monthly Retired couple with 3 years of experience cruising their Victory 40 ketch. Voyage from England to Iceland in late May. Small depression had formed South of Iceland. By morning the wind had picked up to 45 knots and veered about 45 degrees, which produced quite confused seas. Within an hour it had increased to 55 knots gusting to 70, and occasional seas were breaking into the cockpit. At last, we thought, a chance to tryout our series drogue and see if the long hours making it had been well spent.

The effect was immediate: from hurtling full tilt down the face of the huge waves, we slowed down and the waves passed under us. The motion on deck became comfortable and safe. A sight I shall never forget was the drogue warp, stretched bar taut, disappearing into the cliff of water as the next wave approached.

Lessons learned: Series drogues do work. Once deployed, the motion of the boat became safe and we were no longer surfing down the waves with little control. During the seven hours it was trailed we drifted 5 miles through the water, 10.5 miles over the ground according to the G.P.S.

### ***35ft. Cheoy Lee Lion***

My wife and I were on a passage from Block Island, R.I. to the Azores. -approaching Georges Bank with a falling barometer. Running off under bare poles, sustained winds near 60 knots, taking a lot of breaking waves causing some minor damage. We decided to launch the series drogue. Used a primary winch to ease it out slowly and keep it under control.

After deployment our boat speed dropped to 2 to 4 knots and the drogue created a slick behind the boat that split the breaking waves. The waves would roar past on either side, but no more water came on the boat. Relative peace, it was great. The boat felt like it was tethered to a huge rubber band, always being pulled back if the speed increased too much. Sixteen hours later we winched the drogue back aboard and resumed our journey, with confidence level greatly increased.

This is the only report I have where the skipper controlled the drogue during the launching process. The normal procedure is to stow the drogue properly in a bag and then just drop the weight over the stem. There have been no problems with this system. Controlling the drogue might be difficult since significant loads could develop if the drogue were restrained.

### ***Rhode 41, 70 degrees south in the Atlantic***

"I heard this one wave approaching like a steam train, [it] threw the boat over and [I] felt the shocking sensation of huge amounts of water over me; at the same time the noise of breaking glass and all kinds of stuff flying on top of me... The wave threw So Long sideways onto the water; the mast-top was below the surface (toplight was ripped off) and maybe 2,000 liters of seawater entered through the only partly closed companionway... After the knockdown on Friday morning we steered downwind bare-poled, without any sails, and the Aries self-steering kept the boat on course at about 5-6 knots speed. By noon Friday the still increasing wind made the situation critical with still building seas and huge breaking waves. It was not safe anymore to keep the boat unsupported at this speed. For the first time we deployed our new sea-anchor over the stern, a system of 120 little parachutes attached to 200 meters of rope [Jordan Series drogue]. The boat then settled at about two knots of speed and took the breaking seas in a very safe angle over the stern. We could feel the gentle pull of the drogue to keep the boat at a secure angle to the sea... Between Thursday evening and Friday noon the barometer had dropped 18 hp to 992hp, wind north Force 9-10. For the next 41 hours, all day Saturday, until Sunday morning we were drifting with the sea anchor with the wind at storm force and shifting from north to southwest."



### ***A Tense Moment in Drogue History***

National TV news showed a picture of a dismasted yacht located in the western approach to Cape Horn. The picture was taken from a Chilean patrol aircraft. The sea was relatively calm, and trailing from the stem was clearly seen a series drogue. The emails poured in. How did a 44 ft steel yacht manage to capsize with the drogue deployed.

After a day or so a fishing boat managed to rescue the solo skipper. He was in good shape and sent back the following message to Dave, who had sold him the drogue.

"The drogue was set after rollover. I was still moving at less than hull speed with the staysail and did not feel the need to take defensive measures yet. I was making good time and wanted to get around the Horn to avoid the next storm that was coming. Boy was I wrong. Wouldn't go to sea without one."...

### ***Trawler Yachts 3-06***

More diesel powered trawler yachts are making ocean voyages these days. Some of them are carrying the drogue.

Several were built in China and had the drogue aboard for the delivery trip to the U.S. I have no reports of the performance of trawlers with the drogue deployed. The drogue should provide a comfortable and safe ride through a storm.

However, I believe there is one situation, which should be checked. Unlike sailing yachts which, when lying ahull, have the wind force tending to blow the bow down because of the mast and rigging, a trawler has no mast and often has a house in the stern. Thus, the windage tends to blow the stern down.

With the boat lying ahull when the drogue is deployed, the drogue must provide enough drag to pull the stern into the wind and sea. Once the stern is into the wind the water forces are such that the drogue will firmly maintain this position even in a dangerous breaking wave strike. I have added extra cones to the trawler drogue to handle this condition.

However, it would be prudent for a trawler skipper to deploy the drogue in a brisk breeze and with the boat lying ahull, to check whether the stern is pulled into the wind and sea.

### ***A Good Ride***

The drogue has been at sea for over 20 years. The performance has been flawless. Every skipper has reported favorably.

However, a number of skippers, after riding out a very severe storm, have offered some comments, which puzzled me: "As soon as the drogue took up the load the situation changed dramatically. It was like sailing into a harbor of refuge, there seemed to be less wind and the noise of the storm actually diminished. The surface of the sea was less disturbed and the drogue seemed to create a "slick" around the boat." etc.

Of course, the drogue can do none of these things. I attributed these comments to the psychological sense of relief that the skipper felt when the boat was no longer rolling, yawing, and charging down the face of the steep waves.

However, some skippers I knew were not prone to loose statements and I now think I understand how such impressions can actually be experienced.

In a severe storm with large waves, the boat is carried forward as the wave lifts it up the face. Then the crest passes under the boat and the boat descends into the trough. As the severity of the storm increases, the waves become steeper and often have whitecaps with some moving water at the crest. It becomes increasingly difficult for the boat to make it over the top and the boat spends a longer time on the face.

Finally, as was the case with the Winston Churchill, a wave may break with enough moving water at the crest to drive the boat down the forward face of the wave, a very dangerous event.

With the drogue deployed the boat is quickly pulled over the crest of each wave and does not linger on the forward face, the boat spends a much longer time in the trough. Where the wind is less and the surface of the sea is less disturbed. Even the noise or the storm would be reduced when the boat is in the lee of a 15 to 25 ft. wave... Thus the average wind and noise would be less with the drogue deployed, the sea would appear calmer and a more benign ambience is actually experienced.

### ***An Epochal Change in Storm Tactics***

I chose the incidents described above as being representative of different boats and circumstances. Actually I am aware of at least 50 occasions of storm encounters and drogue deployments reported to me by the sailors involved or described in marine publications. In all cases the stories are remarkably similar. The effect of the drogue is dramatic. The situation changes from frightening to relaxing, and the crew often sleeps through the remainder of the storm in relative comfort.

Conventional storm survival lore and literature is no longer necessary or pertinent. Whenever the situation deteriorates to the point where further progress is no longer possible or even when it becomes unpleasant, the logical choice is to ride to the drogue until conditions improve. This also applies in the event of crew fatigue, illness, or the need for a stable platform to permit rigging repair.

Although the drogue was developed using sophisticated engineering tools and procedures, the device itself is very low tech. There are no special materials, no moving parts or controls, no special hydrodynamic shapes. The only material subjected to high loads is the double braided nylon rope. It is poignant to realize that every sailing vessel which went to sea from the time of the Romans had on board all the materials and skills needed to build a drogue which would have been capable of bringing the ship safely through a survival storm. They had strong hawsers used for anchoring, spare sail cloth for sail repair, and a sailmaker with the skill to fabricate the cones.

With the help of the drogue; St Paul on his biblical voyage across the Great Sea could have safely made passage to Rome instead of being shipwrecked in the wilderness, and the spread of Christianity would have taken a different course. The settlement of the American continents might have been advanced by 400 years if the Vikings had the drogue. Their vessels, although

ideal for fast coastwise voyaging, were hopelessly unsafe on the open sea under storm conditions. Since they were undecked, they could not lie ahull without swamping, and if they tried to run off they would surf and plunge into the next wave. The Viking ships had no structural bulkheads and would have split open like a pea pod on impact with the green water in the preceding trough.

With the help of the drogue, the Vikings might have been able to support their colonies in the New World.

So much for conjecture!

## TECHNOLOGY

### ***Research and Development Program -- Don Jordan***

With the data from the 1979 Fastnet Race in hand, I started by making scale models of some of the boats in the race and testing these models in natural waves and man-made waves. It is a fortunate fact that small waves behave like large waves and small models behave like full scale yachts if some simple dynamic similarity rules are observed in the model design and testing. I had no preconceived ideas on what these tests would reveal.

At the same time, extensive tests were being conducted in the U.S. and Europe to determine whether the Fastnet tragedy was caused by the design features of modern yachts compared to traditional designs. "Killer Yachts" they were termed by some leading naval architects. After much effort, it was concluded that there was no significant difference in the capsizing vulnerability of modern yachts or traditional designs. I repeated these tests and got the same results. The Fastnet disaster was caused by the severity of the storm, not the boat design or the tactics of the skippers.

I then undertook a program of basic research and development to understand and find a solution to the storm survival problem. In this effort I was greatly assisted by the U.S. Coast Guard, who made all their applicable facilities available for my use, and finally tested the series drogue in breaking waves at their motor lifeboat test site. The program, which continued for four years, led to the following general conclusions:

1. To protect a yacht in a hurricane, an outside force must be applied from a drag device. No design changes to the boat and no storm tactics on the part of the skipper can result in a significant reduction in risk.
2. The drag device must be a drogue, i.e. the boat must be tethered from the stern. (I have found this to be the most difficult concept to get across)
3. A sea anchor cannot be designed to protect the boat. When tethered from the bow, the boat will yaw and develop unacceptable loads. The reason for this is that all boats must be designed to be directionally stable when moving forward - or it would not be possible to steer the boat. Therefore, if moving backwards, the boat will be unstable and will yaw and turn broadside to the sea.
4. The drogue must consist of multiple drag elements strung out along the tow line. A single drag device of any size or shape will not provide protection.
5. The drogue must be designed so that a significant number of the drag elements are deeply submerged and do not lie on the surface.
6. The design of the multiple design elements must be such that, in a "worst case" breaking wave strike, peak transient load will not exceed the design value for the drogue components or the boat attachments.
7. The strength of the drogue and the number of drag elements must be adjusted to be compatible with the displacement of the specific yacht.
8. With a proper drogue, a yacht and crew can survive a storm of the severity of the Fastnet or 1998 Sydney-Hobart storm with no serious storm damage or crew injuries.

### **Quality Control**

I am an old aircraft engineer. In the design of aircraft, certain machinery and equipment is in a separate category, "safety of flight". These items must be absolutely reliable and must be capable of enduring the worst environment that the aircraft may encounter. The series drogue is designed to this strict safety standard. None of the other various drogue and sea anchor types can meet this requirement.

However, there is only a very small chance that any one drogue will ever encounter a worst case-breaking wave. I have made a strong effort to prevent any compromise or substitution, which might reduce the size, weight or cost of the drogue but might compromise the safety/ Dave Pelissier, has been very conscientious in maintaining the design integrity and quality control.

All drogues are built to a rigorous specification various skippers have proposed ways to "simplify" or reduce the cost of the drogue – such as using 3 strand line or using larger and fewer cones. I have managed to hold the line so far – but I have no control over individual builders.

## DESIGN LOADS and ATTACHMENTS

### ***Drogue Design Load***

The design load for each drogue configuration is adjusted for the displacement of the yacht. The design load is the ultimate, once in a lifetime, peak transient load that would be imposed on the drogue in a "worst case" breaking wave strike. The working load during a severe storm is about 10 % of this value.

MONOHULLS		MULTIHULLS	
Displacement	Design Load	Displacement	Design Load
10,000 #	8,000 #	6,000 #	10,000 #
15,000 #	10,000 #	12,000 #	12,000 #
20,000 #	13,000 #	18,000 #	14,000 #
25,000 #	16,000 #	30,000 #	19,000 #
30,000 #	19,000 #		
35,000 #	22,000 #		
40,000 #	25,000 #		
45,000 #	27,000 #		
50,000 #	30,000 #		

### ***Bridle Legs***

The design loads for each of the bridle legs are 70% of the drogue design loads.

### ***Attachments on the Hull***

The hull attachments for the drogue should be as far outboard and as far aft as possible. I have no information on the ultimate strength of a typical sheet winch installation, and it would be difficult to evaluate each structure. Unfortunately, a winch is not an ideal structure, since the load is applied above the deck line and tends to overturn the winch and pull it out. The optimum attachment for the drogue is clearly a strap similar to a chainplate, bolted to the hull at the corners of the transom and extending aft with a shackle.

For a load of 14,000 lbs, a strap ¼ x 2.25 x 18 inches attached with six 3/8 bolts would provide a conservative design.

A large steel cleat would be acceptable if the deck is thick solid fiberglass and a steel plate is provided underneath.

## LAUNCHING and RETRIEVAL

### ***Launching the Drogue***

One of the design objectives of the drogue is that it may be launched with one hand under storm conditions without leaving the cockpit and that it will not foul even if the boat is rolling or yawing. This capability has convincingly been confirmed as described in *Performance at Sea*.

To prepare for instant launching, the drogue is faked down with the bridle end at the bottom of the bag and the bridle legs led up the sides and fastened to the attachments at the corners of the transom. The weight (chain) is at the top of the bag.

To launch the drogue, the chain is dropped overboard and the drogue permitted to feed out. Within a few minutes, the drogue will gently take hold with no abrupt deceleration.

Through many launchings the drogue has never fouled. In fact, this launching capability has probably saved the lives of a number of sailors.

### ***Retrieving the Drogue***

Unless you do it right, retrieving the drogue can be a real chore. I am aware of three cases where the skipper actually gave up and cut the drogue loose. One skipper in the Southern Ocean waited for two days for the wind and sea to quiet down before giving up.

It is not very practical to put the drogue directly on a winch or to pull it in hand over hand. However, if done correctly, a petite woman should be able to easily and safely do the job without leaving the cockpit. .

With a single cone or chute, as the drogue nears the boat, high loads can develop when the boat pitches, a dangerous condition.

With the multiple cone design, the load diminishes as the drogue comes in. Finally the skipper just lifts the chain aboard. This is an unanticipated benefit.

I asked my friend Noel Dilly how he handles retrieval on his 26 ft. sloop. Noel, who sails from the U.K, is a very experienced ocean sailor and was a pioneer in using the series drogue about 20 years ago... He has done much to gain acceptance for the drogue in the U.K. and in Europe.

He stresses that each skipper must choose the system for his boat. We discussed several methods which differed in detail but not in principle.

The attached sketch shows the basics of the system he uses. The drogue is always under control and cannot impose high loads on the operator.

A line is attached to the drogue with a rolling hitch - or Noel uses a loop. He passes the loop around the drogue and leads it through itself twice. This is easy to tie and remove. The drogue is then winched in 8 ft. or so.

A helper line is then attached and fastened to a cleat.

The winch line is then removed and reattached to the drogue at the transom. The process is then repeated. Depending on sea conditions, this can take about 20 to 30 minutes.

I am always hoping to get feedback from skippers who have used the drogue, but very little has shown up so far...

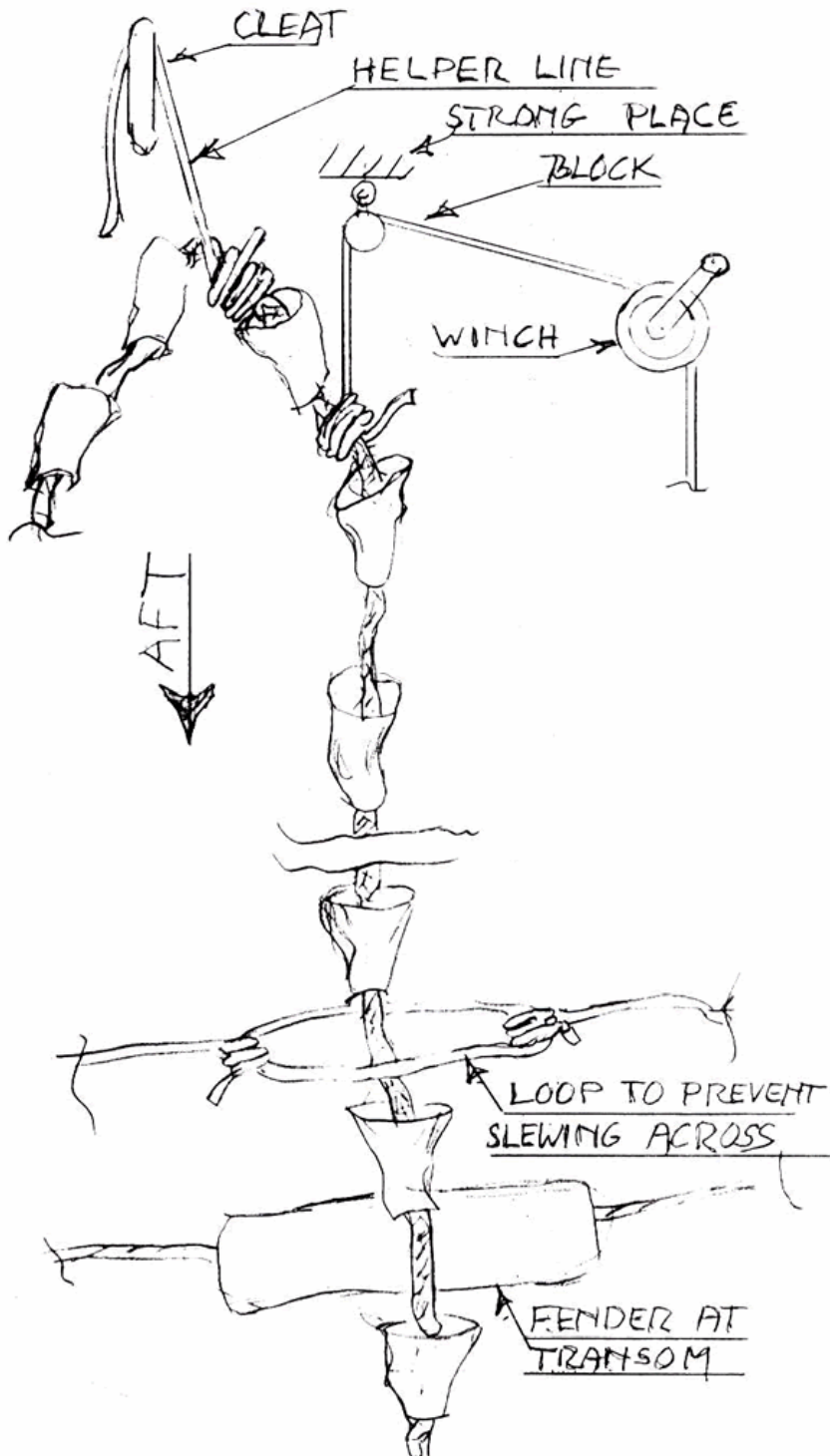

Noel points out that the drogue is seldom used, and when it is, it may have saved your life. Retrieval is really a minor item and can be a good time to meditate about your good fortune.

**Chafe**

In all of the many drogue deployments there has been only one report of a failure due to chafe. I believe that this lack of chafe is due, at least in part, to the relatively low loads and the absence of yaw when the drogue is deployed in a moderate storm. The only time that high loads might be experienced is in the event of a dangerous breaking wave strike.

In this one instance, the skipper reports that the steering gear was surrounded with a heavy steel structure to act as a guard. The bridle legs were deployed above this guard. Investigation showed that as the boat went over the very steep crests the bridle legs could be deflected downward by as much as 35 degrees and would bear heavily on the guard. Fortunately the bridle held up until the worst of the storm was over.



## **ABOUT the DESIGNER**

Don Jordan is a retired aeronautical engineer and spent his career in aircraft and engine development. He has been an enthusiastic sailor all his life and also was a licensed pilot flying small aircraft on wheels and floats.

During the war he worked on the design and development of the Vought Corsair navy fighter which earned the top combat record in the Pacific theatre. After the war he became interested in the new jet engine, and joined Pratt and Whitney Aircraft. He held a variety of positions there, retiring as Chief Engineer just as the first engines were being delivered for the Boeing 747 airplane. Subsequent to his retirement he was a Senior Lecturer at Mass. Inst. of Technology for ten years.

He has served on many government committees including the Air Force Scientific Advisory Board and the N.A.S.A Advisory Committee For Airbreathing Powerplants. In 1976 he was elected to the National Academy of Engineering.



*Don Jordan*

He now lives in Glastonbury, CT with his wife Ruby and enjoys his children and grandchildren.

Don has no financial interest in the manufacture or sale of the drogue. He has provided his own funding for the development. He was greatly assisted by the U.S Coast Guard, who made their facilities available for testing and analysis and who tested the final configuration in breaking waves at the Motor Lifeboat School on the Columbia River bar.

The impetus for his work was the 1979 Fastnet Race disaster in which 15 lives were lost and 24 boats were either sunk or abandoned. He felt that, with his background and with modern engineering tools, such tragedies need not continue.

## ABOUT the BUILDER



*Dave Pelissier*

I, Don Jordan, am writing this for Dave Pelissier because without him and his remarkable energy and dedication, the drogue would have rotted on the beach. Now its reputation has spread throughout the deep sea world, and I, now 89 years old, can be confident that it will continue to be available to sailors for the future.

As a result of my early magazine articles and lectures, a small number of skippers made their own drogues using the Coast Guard Report to define the configuration. One skipper, after using the drogue in a severe Atlantic storm during his cruise from England to Australia, started a company to build and sell the drogue in Australia. Another skipper, the owner of a company making hydraulic equipment in Texas, after riding to the drogue in a near hurricane also decided to make and sell the drogue. There were several other companies in England and the U.S. who started to offer the drogue for sale around 1990.

I made an effort to keep in close contact and personally wrote to all purchasers. However, sales were very low, about 2 to 4 drogues for each company a year. The price of the drogue was high, about \$2000, considerably more than a government surplus parachute, the main competitor. Many skippers who choose ocean sailing as a way of life do not have very much money and the price was a serious deterrent. Somewhere I remember reading that the total estimated market for drogues was probably around 10,000, not a number on which to get rich. Gradually all the companies gave up the battle and ceased to offer the drogue.

I realized that, despite the successes at sea, the whole project might fail. As a final move I wrote to a number of sailmakers. All expressed no interest. A few weeks later I received a call from a young man who said he worked at a local sailmaker and had seen my letter. He was leaving the company to start a small sail repair business with his father as a helper and would like to make the drogue. We got together and I started to refer interested skippers to him. He managed by hard work and clever procedures to lower the cost from \$2000 to \$1000. He also offered low cost do it yourself kits and he gave competent and responsive service to all skippers, including special deals to poor but deserving types.

For the past fifteen years as the owner of Ace Sails, Dave Pelissier has made most of the drogues in the world except those made by the skippers themselves. I believe that there may be at least 1000 afloat. I have the addresses of drogue owners in 20 countries and 30 states. If it weren't for the good work of Dave and his company, I do not think that the drogue would have survived and prospered.

A great majority of ocean sailors go through life without encountering a survival storm. Whenever such a storm strikes there is a flurry of drogue sales. It is a real tragedy that, while my 20 years of effort was devoted to preventing a recurrence of the 1979 Fastnet, none of the unfortunate boats in the 1998 Sydney Hobart race carried the drogue.

Ace Sails refers all technical questions to me and I answer emails every week or so from skippers all over the world.

By now Dave and I have the satisfaction of knowing that we have probably saved the lives of many sailors and that we have made a lasting contribution to safety at sea.

## STORM WAVES

John Rousmaniere writes, in his excellent book *Fastnet Force Ten*, "The calamity in the Western Approaches (The Fastnet Tragedy) seems to be yet another indication that our positive faith in technology may be groundless. We appear to be led by transitory successes into the heresy that we can completely manipulate our environment". This view of the unworldly fury of a storm at sea has existed thru the ages. Fortunately it is no longer is pertinent.

When I started to work on the capsize problem I had no doubt that it would be possible, in the modern world, to provide equipment to bring a well found yacht thru a storm like the Fastnet or the Sydney Hobart. Water is a familiar fluid. Wave speeds and heights are well within engineering experience. Any competent Aerospace company has handled problems much more challenging. However, I was not at all confident that the required equipment would satisfy the constraints of size, weight, cost, complexity and ease of operation to an extent that it could be expected to gain acceptance by ocean yachting skippers. The series drogue has now earned that acceptance, but it took 15 years or so to get there.

In addition to a feeling of helplessness, there is another irrational attitude that countered our obtaining a solution to the capsize problem. The shape and motion of storm waves when viewed from the deck of a yacht are such that it can lead to optical illusions which confuse the skipper. A large storm wave approaching the boat appears to be a dangerous wall of water and the skippers instinctively tend to head up or run off to avoid being pooped. Actually the water in the wave is not moving towards the boat and will lift the boat harmlessly.

A second optical illusion is that a dangerous breaking wave comes from a direction different from the prevailing wind and sea. The report of the Investigating Comm. for the Hobart Sydney disaster states "Exceptional waves were responsible for inflicting the damage or causing severe knockdown to yachts. These waves were 20 to 100% larger than the prevailing seas and came from a direction other than the prevailing wave pattern".

From physical considerations it is virtually impossible for a breaking storm wave to approach from a significantly different direction. Breaking waves are formed by the wind and by the addition of the energy of the smaller waves that they overtake. If a wave moved across a series of smaller waves it would lose all its energy in turbulence. We have many aerial views of the sea surface in the Sydney Hobart storm. If a large wave had moved across the smaller waves we would see a white streak running across all the other streaks. There is no such a streak. What actually happens is that if the boat is lying at some angle to the prevailing sea as the breaking wave approaches, the action of this wave yaws the boat until it is abeam. This yawing motion is not observed by the skipper and he thinks the wave direction has changed, whereas it is the boat that has moved. It is true, however, that the waves that caused the damage were "exceptional"

In gale force winds most of the waves can have breaking crests, but the speed and height of the waves are such that they do not constitute much of a threat.. However, in hurricane force winds the sea is generally blown "flat", but from time to time very large and dangerous waves appear,

often moving in pairs or groups. A boat can ride for hours without encountering such a wave and then be destroyed in seconds.

Another optical illusion is that it is possible in a survival storm to reduce the hazard by running off before the waves and, by skillful seamanship, to out maneuver a dangerous wave. This is a particularly unfortunate choice. The waves are moving faster than the boat can go. A 40 ft .breaking wave will be moving at a speed of approximate 23 knots. The breaking wave is completely random. Furthermore, by far the most important concern is that, if the boat is moving through the water, the chance of being caught by the wave and surfing to a dangerously high speed is greatly augmented.

In the modern world we have an understanding of storm waves. There is no more mystery. Such terms as "rogue waves" serve to confuse the issue. For over a hundred years we have had an engineering grasp on non-breaking waves but it is only in the last 30 years or so that we have been able to determine the position, velocity and acceleration of every water particle in a dangerous breaking wave.

A final misconception is the belief that a breaking wave "strikes" the boat and that the moving water in the crest does the damage. Actually, the boat is lifted by the forward face of the wave with no impact. When it reaches the breaking crest the boat velocity is close to the wave velocity. The crest water is aerated and has little damage potential. Damage to the boat is incurred when the boat is thrown ahead of the wave and impacts the green water in the trough. The leeward side and the deck are struck. A careful reading of "Fastnet Force Ten" and "Fatal Storm" will confirm this conclusion.

## WAVE SCIENCE

### ***Non-Breaking Waves***

Scientists began to study waves in the late 18th and early 19th centuries. They used a flow channel in which they could measure the speed, height, and velocity of regular waves.

They found that the wave speed and the wave length could be defined by a simple formula:

$$\text{WAVE SPEED} = \sqrt{\frac{gL}{2\pi}} \quad \begin{array}{l} L = \text{WAVE LENGTH FT} \\ g = 32.2 \text{ FT/SEC}^2 \end{array}$$

Thus a wave with a wave length of 300 ft. will have a wave speed of 39 ft/sec. (23 knots) and a period between wave crests of 7.7 seconds.

For regular waves the wave height does not affect the wave speed.

These simple relationships help us understand that waves are packets of energy floating on the water surface. Each wave is similar to a pendulum. The mass of waters moving up and down is the weight and the wave length is similar to the length of the arm of the pendulum.

Note that the weight of the water or the weight at the bottom of the pendulum has no effect on the period of either a wave or a pendulum. In fact the formula for the period of a simple pendulum is remarkably similar to that of a wave.

$$\text{Period of a wave} = A \sqrt{L} \text{ seconds} \quad \text{Period of a pendulum} = B \sqrt{L} \text{ seconds.}$$

Where A and B are constants and L is the wave length and pendulum arm length. Thus waves formed of liquid lead would have the same speed as water waves

A pendulum would have the same period if the weight were lead or brass. Of course this is why pendulums were used for clocks.

From these studies we can obtain an effective engineering understanding of regular waves. However, regular waves do not threaten a well found yacht unless the yacht is permitted to surf down the forward face and reach a high speed.

### ***Breaking Waves***

When scientists increased the height of the waves in the flow channel by moving the paddle more violently they observed that the waves became very steep and collapsed forming a breaking wave. They determined that the waves would break when the wave height exceeded 1/7 of the wave length.

Similarly we know that a pendulum will cease to function if it swings up too high.

A wave breaks because its crest is too high for the forward speed of the wave. The water cannot get over the crest, just as a yacht cannot get over.

When a wave breaks, water cascades down the forward face of the wave. Sailors have described the face of a breaking wave as a waterfall. The falling water makes a roaring sound, and from ancient times such waves were known as "growlers".

### ***Worst Case Breaking Wave Strike***

I have chosen the case of the Winston Churchill in the 1998 Sydney Hobart race as an example of a worst case breaking wave. The Churchill was a classic wooden sloop of 25 tons displacement and 55 ft. LOA. Of the experienced crew of 9, two perished in the accident.

From "Fatal Storm" by Mundle. "A sea came out of nowhere", said Stanley, "I could feel it from where I was in the aft coach house. It picked the boat up and rolled it down its face - 25 tons of boat- into the trough at a 45 degree angle. It was like hitting a brick wall when we hit the bottom". A crewman below reports that a sudden motion of the ship picked him up and threw him 7 ft. He observed that 8 ft of the heavy timber bulwark and planking had been torn off near the leeward shrouds, and the ribs were exposed. . The boat filled rapidly and sank in a matter of minutes.

This is an unusual type of accident. Although there are records of many storm casualties, I am aware of no documented instance of a well found yacht of the size and reputation of the Churchill and crewed by an ample group of expert sailors, suffering such catastrophic structural damage that it sank in a matter of minutes. How could this possibly happen? The severity or the storm was extreme but by no means unprecedented. There are numerous reports of large sailing yachts surviving hurricanes of the same general magnitude. Although yachts have been lost in such storms I have been able to find no record of comparable structural damage.

History shows that the probability of a yacht being capsized and damaged by a large breaking wave is strongly influenced by the displacement of the vessel. Yachts under 35 ft. have a poor history while yachts over 50 ft are rarely capsized and damaged.

The nature and extent of the damage incurred by the Churchill is also most unusual. The vessel was designed by Sparkman and Stevens and was maintained to the highest standard. Yet the heavy timber bulwark was shattered, the planking gone and the ribs exposed.

There is no question of the fact that the leeward bow of the boat was driven into solid green water at an extremely high velocity, far higher than would be expected in a simple contact with a breaking wave. We now have a technical understanding of how such a destructive force can be generated. Observations from many experienced sailors on a number of the SH yachts provide data which permit a sound engineering analysis of the performance of the waves and the boats in the race.

Water forces are applied to the hull of a yacht by two means, buoyancy forces and dynamic forces. Buoyancy forces are the familiar pressure forces which keep the boat afloat. They never reach sufficient magnitude to damage a well found yacht.

Dynamic forces result from the motion of the boat relative to the water, either as a result of the boat velocity or the water velocity due to wave motion. A speeding power boat can be destroyed by striking solid water. Similarly, a sailing yacht can be destroyed if it is accelerated up to a high speed by a breaking wave strike and then impacts solid green water in the preceding trough. This is the fate that befell the Churchill.

To understand this phenomenon we must consider the concept of energy. A moving car or boat has energy. This form of energy is called kinetic energy. Kinetic energy is measured in foot-pounds. Kinetic energy can be calculated by the formula  $KE = 1/2 (w/g) \text{ times } (v^2)$ . Where  $w$  is the weight of the car or boat,  $g$  is the acceleration of gravity ( $32.2 \text{ ft./sec}^2$ ) and  $v$  is the velocity in  $\text{ft./sec}$ .

Thus a 3,000 lb. weight traveling at 30 mph (44  $\text{ft./sec}$ .) would have a kinetic energy of 90,000 foot pounds. Now...and this is very important to our understanding of the Churchill disaster...if the moving vehicle strikes an object, the kinetic energy determines the severity of the collision and the extent of the damage.

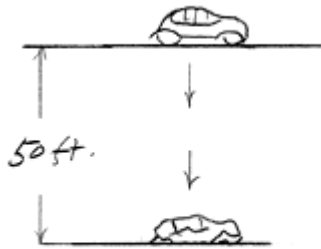

FIG. 1

In addition to energy due to motion, a vehicle can possess energy due to height. This type of energy, also measured in foot pounds, is calculated simply as the height times the weight. A 3000 lb car hoisted to a height of 50 ft. would have 150,000 foot pounds of energy. If dropped from 50 ft to a solid surface, the car would dissipate this energy in damage. If the car was compressed by 2 ft. the average force during the impact would be 75,000 pounds. If it landed on its top and compressed four feet (because it was softer)

the average force would be 37,500 lbs . . . .These numbers (compression and force) are not precise but the product must be the same to satisfy the energy balance.

Since a car accident is a more familiar event than a wave strike I will continue with this analogy since it is technically identical to the Churchill event.

**Fig.1** shows a car being dropped from 50 ft. It will impact the ground at 57  $\text{ft./sec}$  (39 mph) and will have a collision energy of 150,000 ft. pounds. It will sustain the appropriate damage.

**Fig. 2** shows the car on a ramp 50 ft. high. The car rolls freely down the ramp and strikes a tree. The velocity at the bottom of the ramp will be the same as if the car had been dropped vertically, that is 57  $\text{ft./sec}$ . Thus the collision damage will be comparable to that of the vertical drop.

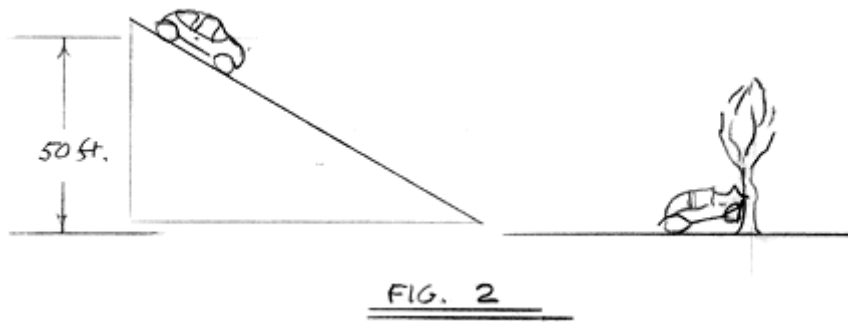

FIG. 2

Now we come to the key element in our study of storm damage. This explains why the crew of the Churchill felt an impact similar to that of striking another boat.

**Fig. 3** Here we assume that the entire ramp is mounted on wheels and is propelled toward the tree at 30 m.p.h. The moving ramp simulates the front face of a large breaking storm wave. The car is released from the top of the ramp and is permitted to roll down the face. The "increase" in speed while descending the ramp is the same as when the ramp is stationary, 39 m.p.h... Thus the final speed of the car as it leaves the ramp and strikes the tree is 30 plus 39 or 69 m.p.h..

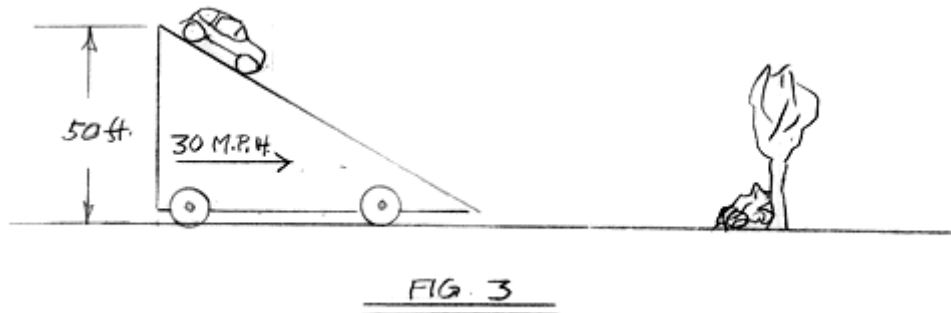
FIG. 3

However since the kinetic energy (collision energy) varies as the square of the speed, the kinetic energy (collision energy) is 480,000 foot lbs or over 3 times as much as if the ramp had been stationary. There is no other wave - boat interaction which can generate such destructive loads.

The wave in this event acts as a sling shot, hurling the vehicle, car or boat forward at a high velocity. This is the mechanism which destroyed the Churchill and the same mechanical system that David used to destroy Goliath.

With this understanding we can design a simple system to decelerate the boat before it strikes the solid water in the trough.

### ***An Experiment***

The sling shot concept can seem arcane. Actually it is simple.

It can be accurately observed with no special equipment. All it takes is a shovel with a curved blade and a golf ball.

Place the golf ball in the center of a garage or cellar with a level floor. Walk across the cellar at a constant (approximate) speed pushing the shovel towards the ball. Adjust your walking speed such that the ball is picked up and ascends up about  $2/3$  of the shovel height.

Maintain your walking speed constant as the ball rolls down the blade and proceeds to outrun the shovel. Except for friction effect, the ball will leave the shovel at twice the speed at which you were walking. When it strikes an object it will have 4 times the collision energy of a ball moving at shovel speed.

## "THE LOSS OF THE WINSTON CHURCHILL"

We now have enough information that we can apply the same analyses to the Winston Churchill.

We can estimate the speed of a breaking wave (but not a non-breaking wave) if we know the height of the wave. The breaking wave that destroyed the Churchill was estimated by several observers to have a height of at least 45 ft. Such a wave would be moving at about 30 mph. Therefore, when the boat had been picked up by the wave it would be moving at that speed.

As the Churchill slid down the face of the wave on its side, there would be very little friction or drag, because the water supporting the boat would be moving at the same speed and would accelerate with the boat. With no friction the boat could reach a speed of 67 mph by the time it reached the trough. If we assume only half of this speed increase, the boat would strike the green water in the trough at over 50 mph.

This velocity is equivalent to a free fall from over 70 ft. This clearly explains the sequence of events which destroyed the Churchill. A boat striking green water at this speed can incur a force of over 200,000 lbs.

### *Winston Churchill with Drogue*

It is not feasible to design a drogue which will prevent a boat from being picked up by the wave and carried up to wave speed. The loads would be prohibitive. Therefore it is necessary to design a drogue which is capable of decelerating the boat to a low speed before it plunges into the trough.

**Fig . 4** shows the Churchill in the trough of a 45 ft breaking wave. A series drogue has been deployed and the boat is dead in the water. The wave face is moving toward the boat at over 30 mph. The drogue device consists of 164 5in. diameter cones concentric with the towline and attached to 348 ft.of double braided nylon line tapered from 7/8 to 3/4 to 1/2 in.diam. A 30 lb. weight, usually a length of chain is attached to the end.

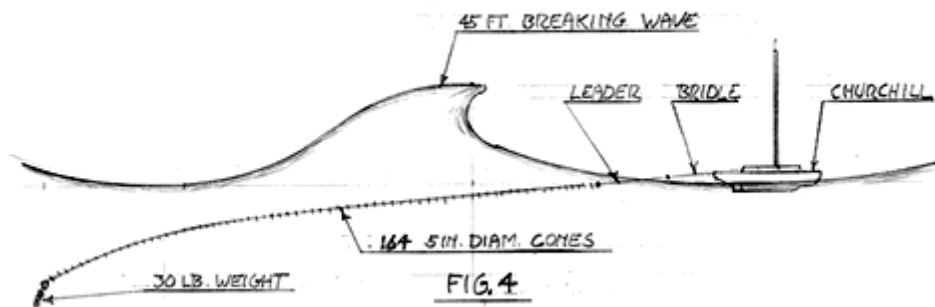

**Fig. 5** shows the boat as it reaches the wave face. A heavy boat such as the Churchill is not thrown ahead of the wave but is caught up by the wave and brought up to wave speed. The

loads on the boat when struck by the crest are not high enough to cause damage. The boat rides up the face and is near wave speed when struck by the moving water at the crest. In the more than 15 years that the drogue has been at sea, no boat has ever been damaged. In particular the rudder, transom, cockpit and companionway doors have all been unscathed.

At the position shown in **Fig. 5**, the drogue has picked up a load of approximate 5000 lbs.

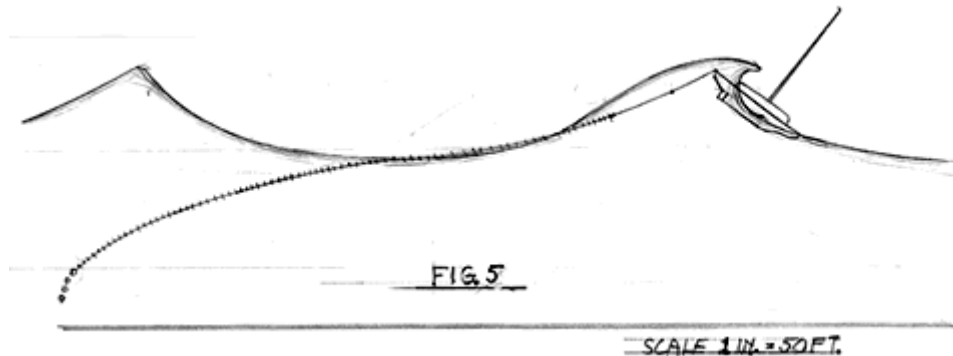

This is sufficient to avoid yawing and broaching but not sufficient to prevent the boat from being driven up to wave speed.

**Fig. 6** shows the Churchill surfing down the face of the wave. The crest has broken and the surface water is moving with the wave. Without a drogue the boat would accelerate rapidly. However, at this point the drogue has straightened out and is reaching the peak load, approximate 25000 lbs or half the displacement of the boat. The boat now decelerates and reaches the trough at a moderate velocity and with little roll or yaw.. No high loads are imposed on the hull or rigging.

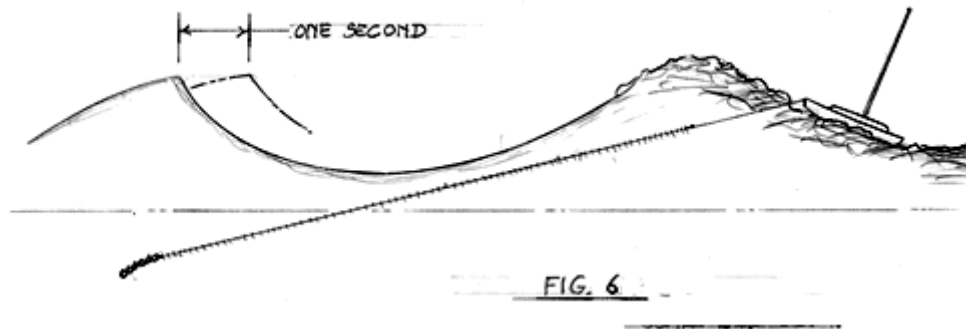

**Fig. 7** shows the Churchill without a drogue impacting the trough at a speed of over 50 mph. This is why the crew reported that "It felt like we had struck another boat".

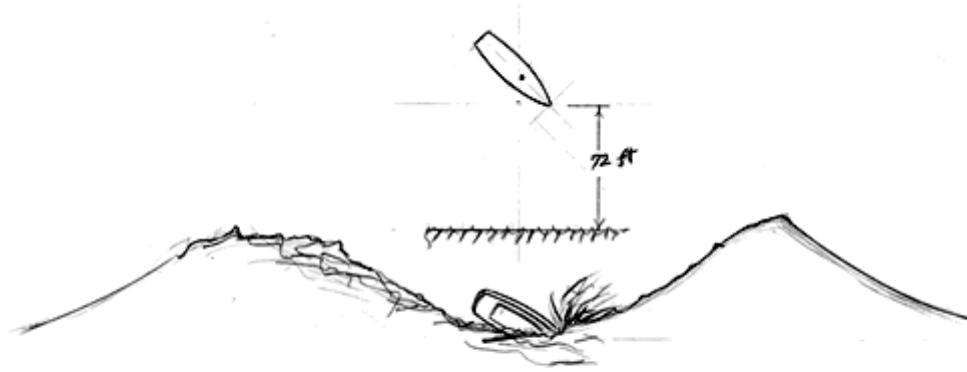
FIG-7

The wave characteristics discussed here and shown on these figures are taken from a computational fluid dynamics simulation. Although actual storm waves will have local surface variations, the energy level and dynamic behavior of large waves such as those that struck the Churchill are now well understood and predictable for engineering purposes.

The following section has generated little interest so far.. I even mentioned it to a couple of Marine insurance companies to no avail. However, I finally picked the following up on the web.

"Have you ever tried anchoring from the stem? I anchored the other weekend for an experiment in 20 to 30 knots out in the open. The difference between how our Seraph 25D behaves stem to as opposed to bow to was utterly amazing. Sure we had wave slap and some spray into the cockpit, but she just sat there and pointed into the wind with every shift. By the bow she dances around like a drunken ballerina, sailing off one way, snatching up on the anchor line, turns, and off she goes the other way. The anchor sail on the backstay helped but she still wasn't nearly as composed as when her stem was facing the waves. Mr. Jordan will tell you why this works... And more importantly maybe, why sailing vessels USED to be able to get away with bow anchoring and why modern sloops just can't ;without sailing all over the place."

## MOORING AND ANCHORING

In the fall of 2004, four hurricanes devastated southern Florida.

"Hurricane Ivan struck the Gulf Coast causing extensive damage. Insured U.S. losses exceeded \$7 billion". Science News, April 05. The media showed scenes of marinas with a shambles of damaged boats. Boats from moorings and anchors littered the shore.

"Yachting World, -- Nov. 1996, Hurricane Bertha, British Virgin Islands, Moorings are vulnerable in the wind. It is particularly unnerving to watch the yachts tacking back and forth and blowing flat at the end of each tack, Chafing is one the biggest enemies of hurricane survival" See Fig 1.

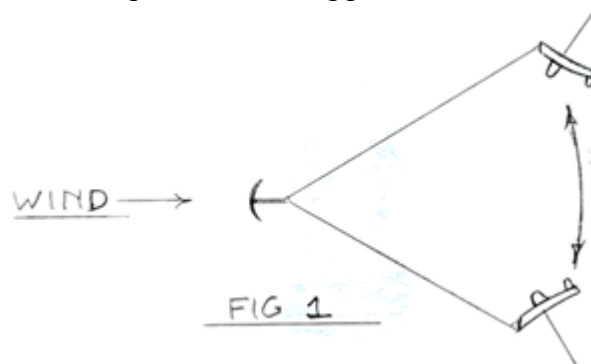

The research which led to the design of the series drogue, and even more important, the actual experience at sea with a variety of yacht designs, and with storm encounters up to hurricane strength, can provide another benefit to the yachting community.

These engineering data clearly show that, in storm conditions, a sailing yacht should be moored or anchored from the stern with a bridle, not the bow. If moored from the stern, the boat will lie quietly and will weathercock with changes in the wind direction.

The design loads for the mooring or anchor can then be estimated with sufficient accuracy to permit the design of a reliable mooring system for hurricane winds. There is no technical reason why a sailing yacht need break away from a mooring. The wild and destructive motion shown in Fig. 1 is caused by a form of dynamic instability which is now well understood. Similar unfortunate behavior was experienced on early aircraft designed to fly at high speed. Now known as flutter, the wing would twist and oscillate up and down with increasing amplitude until

failure occurred. A similar but more widely publicized event was the failure of "Galloping Gerty" the Seattle Tacoma suspension bridge, which undulated in the wind until one day, in a heavy gale, the vibrations grew so severe that the bridge broke into pieces.

Not all boats become dynamically unstable when tethered from the bow in a strong wind. However modern sloop rigged yachts with a cutaway forefoot, short keel and spade rudder are particularly vulnerable. Such designs make up a large share of the yachting communities. A schooner rigged yacht with a long straight keel is better, and most of the old gaff rigged schooners would ride fairly well. Power boats are often better than sailing yachts. However, boats with a high bow and a large structure forward can do poorly. All designs would be more secure anchored-from the stern.

Fifteen years at sea with the series drogue has demonstrated that a yacht will not be "pooped", and the rudder and companionway doors will not be damaged by mooring from the stern. The cockpit may occasionally fill from waves slopping aboard.

### ***The Stability of Anchored or Moored Sailing Yachts***

If an anchored sailing yacht is stable it will lie quietly. If it is unstable it will develop a violent motion under high wind conditions. An object is said to be stable if, when a force is applied to deflect the object, an opposing force is generated to return the object to the original course. All moving vehicles, boats, cars, bicycles, airplanes, etc. are designed to be stable when moving forward. Otherwise it would not be possible to steer them in a straight line. If a vehicle is stable moving forward, it will be unstable moving backward.

The most familiar example of an object with positive directional stability is an arrow.



An arrow is highly stable moving forward  
If deflected from its course, the feathers act to bring it back.

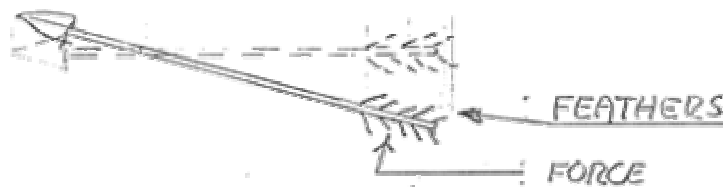

If an arrow is tethered at the arrowhead end and exposed to a strong wind it will be stable and will lie quietly, aligned to the wind.



If the arrow is tethered at the feather end, it will be unstable and will flail around wildly.

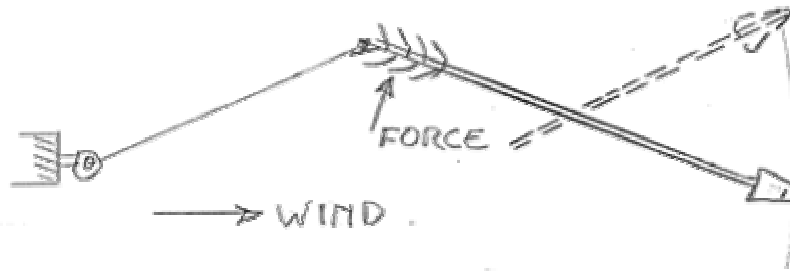

The motion of an arrow is influenced only by air forces. However, the motion of a sailing yacht is influenced by both air forces and by water forces. All sailing yachts are designed to be stable when moving forward through the water. Therefore, they will automatically be unstable when moving backward through the water, as any skipper who attempts to steer the boat backward will attest. The boat will yaw.

### **Water Forces:**

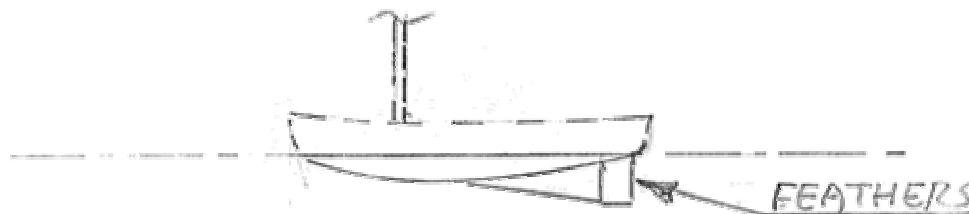

When sailing forward, the keel and the rudder act as the feathers on the arrow. When under sail, the air forces on the sails and rigging are balanced so that the loads on the tiller are minimized, and the air forces do not have an important effect on the directional stability. The boat will hold the desired course with little control from the skipper.

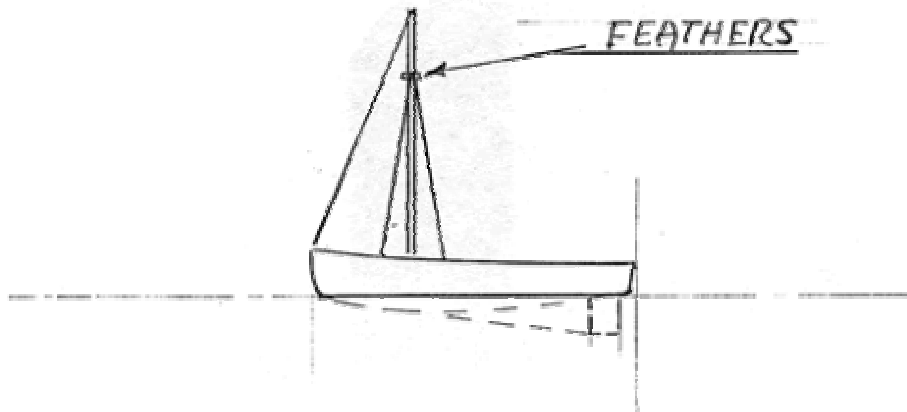

**Air Forces:**

However, and this is a critical point, when the boat is at anchor and the sails are down, the mast and rigging act as the feathers on the arrow. Since the mast and rigging are located at the forward part of the boat, ahead of the center of gravity, the boat will be unstable, and will develop a violent motion in a strong wind such as a hurricane. The force on the mast and rigging of a conventional 40 ft. sloop will be approximate 800 lbs. in a 75 mph hurricane wind. When anchored from the bow in a hurricane, the boat is, in effect, moving forward through the air at a speed of 75 mph., a situation similar to a boat on a trailer being towed at 75.

**An Unstable System:**

A tethered boat will be unstable if, when the boat yaws due to a wave strike or change in wind direction, forces will be created which act to yaw the boat further. The boat will continue to yaw until fetched up and brought about by the load from the tether. The sketch below shows a boat tethered from the bow. A wind shift of 30 degrees strikes the boat. The boat starts to move sideways. The air force on the mast and rigging tends to move the bow further away from the wind. The sideways motion also causes water loads on the keel and rudder, which move the stern upwind, thus further increasing the yaw

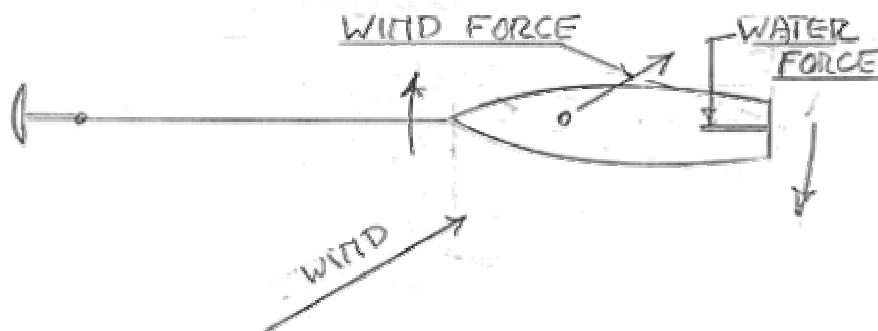
**A Stable System:**

A tethered boat will be stable if, when the boat yaws, forces will be created which act to reduce the yaw and return the boat to the original course or, in this case, turn the boat into the new wind

direction. This sketch shows the boat tethered from the stern. The air force on the mast and rigging now acts as the feathers on the arrow and aligns the boat with the new wind. Also, the water forces on the keel and rudder now act to align the boat with the wind. The higher the wind and water forces the more firmly the boat will be aligned. Many skippers have commented on how aggressively the series drogue holds the stern into the wind and waves in a storm at sea.

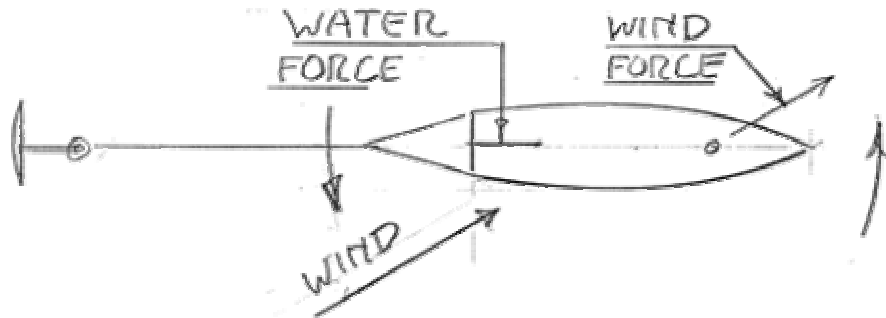

### ***An Engineered Design for Moorings:***

To design a dependable mooring system it is necessary to establish a reasonable maximum load, which will cover all anticipated storm conditions. To my knowledge, this has never been done. Moorings have evolved empirically over the years. If moored yachts are unstable and sail back and forth, it is difficult to establish the peak loads. The maximum load will occur when the yacht reaches the end of the excursion and is blown flat. This load can obviously be relatively high. The air loads can be high since the boat can be broadside to the wind. In addition, the air loads can be greatly augmented by dynamic or inertia loads as the boat is yanked to a stop, blown flat, pivoted 180 degrees, and then accelerated in the opposite direction. The most common form of failure is chafing of the tether as the load goes from zero to maximum in one direction and then from zero to maximum in the other direction. The transient loads continue for hours during the course of the hurricane.

If the tethered boat has adequate directional stability, and weathercocks into the transient wind shifts, the maximum load on the mooring can readily be predicted with acceptable accuracy for design purposes. There will be no significant dynamic forces. The forces from the 4 to 6 ft. waves formed in the harbor by hurricane winds will generate very low loads.

The primary loads will come from the air loads on the hull and rigging caused by the hurricane force winds. Fortunately, very complete data on the aerodynamic drag of all reasonable objects are available from testing in wind tunnels and other facilities. If we consider a typical modern 40 ft. sloop rigged yacht in a hurricane rated at 100 mph, we know from boundary layer measurements that the velocity near the surface will be less than that of the main stream because of friction with the water surface. The velocity near the water surface will be about 60 mph and at the mast, 75 mph. Under these conditions, the drag of the hull, facing stern to the wind, will be about 300 to 400 lbs. and the drag of the mast and rigging will be 700 to 800 lbs. We might use a conservative estimate of 2000 lbs for design purposes. The breaking strength of a three quarter inch nylon mooring line is 16,000 lbs.

Chafing should be easily avoided when the load is relatively steady in magnitude and direction. There is no technical reason why a mooring should fail in a hurricane. In fact, a properly designed mooring may well be the safest haven for a sailing yacht in a hurricane, far safer than a crowded marina or a quickly chosen "hurricane hole."

To conclude this discussion, we might ask why, over the thousands of years of sailing experience, did not sailors realize that a sailing yacht should be moored from the stern, not the bow. The answer lies in the difference between the design of traditional vessels from the age of sail and the design of modern sailing yachts. Traditional vessels had a long straight keel running all the way to the stern. The rudder was small and did not extend below the keel. They were mostly schooner or square rigged, and they were heavy and deep in the water. The resultant wind force on the masts and rigging was aft of the center of the boat. As a result, they came about slowly and often with some difficulty.

Conversely, modern yachts have a short deep keel and a cutaway forefoot. They also have a powerful rudder and are light in weight. The single mast is tall and is located ahead of the center of the boat. These features are necessary to obtain good upwind performance and agility when coming about. However, they make the boat highly unstable when tethered from the bow in a strong wind. Fortunately, the more unstable a boat is when tethered from the bow, the more stable it will be when tethered from the stern. Fifteen years of experience with the series drogue tethered at the stern has demonstrated that, with hurricane force winds and even when buffeted by large breaking storm waves, the boat will ride quietly and will quickly adjust to wind shifts and random wave strikes.

There can be little doubt that a proper stern mooring would have saved many of the moored boats that were destroyed in the four hurricanes that struck Florida in the fall of 2004.

**Additional Information**

Coast Guard Report CG-D-20-87 [Jordanseriesdrogue.com/drogue\\_coast\\_guard\\_report.pdf](http://Jordanseriesdrogue.com/drogue_coast_guard_report.pdf)

If you have any comments or questions on drogue sales or configurations, please email them to [AceSailMakers@yahoo.com](mailto:AceSailMakers@yahoo.com) or call us at (860) 739-5999.

On drogue design or technology, please email them to [donaldjordan@att.net](mailto:donaldjordan@att.net) or call at (860) 633-1702.

Website: [www.jordanseriesdrogue.com](http://www.jordanseriesdrogue.com)

Website designed and maintained by [Computer Management & Integrators, Inc.](http://ComputerManagement&Integrators.com)  
[mfortin@computermanagement.com](mailto:mfortin@computermanagement.com) or call (860) 537-6564.

